



HYGIENE
WITH A
SOPHISTICATED
AND
SUPERIOR
SYSTEM.



WEL COME

MODERN HYGIENE SUPPLIES FOR MORE THAN 50 YEARS.

Ille is the washroom service specialist for all sectors including business, education, technology, catering and hospitality. With 35 service branch offices in Europe, 14 of which are in Germany alone, we supply more than 40,000 satisfied customers worldwide.

For more than 50 years, Ille has led the way for innovation and market-defining top products, a dense international sales and logistics network and a customer-oriented installation, supply and maintenance service, which has no equal when it comes to flexibility, friendliness and speed of service.

In our main catalogue you will find inspiring news and interesting suggestions. If you would like to learn more, schedule an appointment with us. We will be happy to advise you.

To find out more interesting facts about our company, please visit us at www.ille.eu.

We hope you enjoy browsing and reading.



Marion Gottschalk
Managing Director
Ille Papier-Service GmbH



Wilhelm Blatz
Managing Director
Ille Holding

ILLE

A FAMILY
BUSINESS
WITH HEART
AND MIND



Ille is a growing family business that has enjoyed worldwide success. Founded in 1965 by husband and wife team Wilhelm and Helmtraud Blatz (nee Ille), Ille is today the market leader in the field of washroom hygiene. In recent years, the second generation has been successfully integrated into the company and management turned over to daughter Marion Gottschalk, her husband Eric Gottschalk and Andreas Trostmann. They continue to attach great importance to standard-setting sustainable products, highly trained employees, the highest level of customer satisfaction and first-class service.

SERVICE AND QUALITY



01 The new administrative and logistics building
02 Our reception area in Ille style

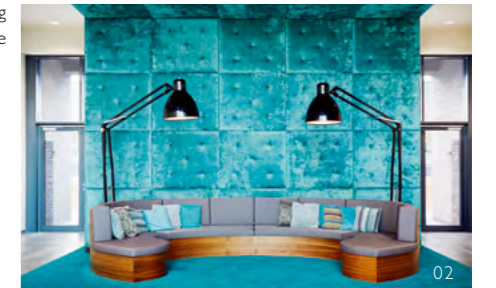

ILLE – WE STAND FOR SERVICE AND QUALITY.

Service and quality are our top priorities. Our well-trained and friendly service specialists are always ready to respond to your inquiries and are in direct contact with our technicians and engineers. That way our products can be further developed on a continuous basis, constantly optimizing solutions for your needs.

To assure the quality that has distinguished us for over 50 years, we invest heavily in our employees. We provide outstanding initial career training, support dual courses of study and offer continual training to our employees – who thank us for it through their many years of service. In addition, permanent quality control of all products is of course a given with us.

See for yourself. Our knowledgeable sales team is happy to advise you in a personal meeting. We will visit you at your location and together develop the optimal solutions for your bathrooms and washrooms.

- 01 Delivery in record time – thanks to trained staff
- 02 Guaranteed full stock with the full-service subscription
- 03 Our new and improved logistics centres are well organised



01



02



03

LOGISTICS

AND SYSTEM

Our logistics network ensures our constant ability to supply our service branch offices. For this reason, you never run out of product. We supply you with dispensing systems and refills (such as paper rolls, disinfectant, skin-friendly soap etc.) and regularly provide supplies. You do not have to place an order – that's included in the service. In emergencies, we can supply you in minimal time, at fair market price with no additional cost. See for yourself.



PRODUCTION AND DEVELOPMENT

Our production of dispensers in the centre of Europe, in Altenstadt, is revolutionary. All devices are developed by German engineers and are produced with the greatest precision "Made in Germany". The dispensers are designed with the aim of the highest possible reliability in order to ensure faultless and long-lasting operation. They remain the property of Ille and are our best advertising medium. If the dispensers should ever need repairs, this is done quickly and simply by our fitters at no additional cost. This is possible thanks to the modular design and the reduction in components.

Ille quality

Before a dispenser leaves our premises, it goes through a multi-stage quality control process in which every component and every function is critically examined. The final inspection is done by our fitters during initial setup in order to ensure that users on site can only use perfect hygiene devices which meet their requirements. Our devices are used by more than 40,000 customers and are tested to the limits of resilience every day. Ille thus receives quick and direct feedback from a wide variety of customers. This process allows for a continuous optimisation process and quick reaction times which both the customer and Ille benefit from.

Ille 100 %

Not only do we take on the investment in the dispensers for our customers, the rental model is also particularly sustainable. Ille takes the dispensers back time and again and prepares them for reuse. 80 % of the parts are thus used again. The rest of the parts are sent for plastic recycling. We achieve a total recycling rate of 100 %. That's as good as it gets.

Hygiene takes energy

Our dispensers are available as a mechanical and an electronic variant. We are convinced that prudent use of the mechanical variants achieves the best hygiene results. Often, though, it's the subjective feeling of hygiene that matters. Our electronic variants offer contactless operation of the hygiene dispensers. We are constantly optimising our electronics for the lowest possible energy consumption. The dispensers can be connected to the mains, but it is often much easier to use them with the batteries which have been specially developed for Ille dispensers. These are characterised by an extremely long life thanks to perfect coordination.



SUSTAINABILITY WITH A CONCEPT

RESPONSIBILITY TOWARDS PEOPLE AND THE ENVIRONMENT IS IMPORTANT TO US.

Our highest priority is protecting people against infectious illnesses. Maximum quality and efficiency in the bathroom and toilet facilities through the sustainable use of resources produces results which are as outstanding economically as they are ecologically. We win you over to the Ille comprehensive package with dedication and service. Reliability and integrity are also of great importance here because considerate dealings with one another and mutual trust make a lasting contribution to a long-term business relationship. Ille is constantly striving to live up to this aspiration to bring the economic, ecological and social aspects into harmony. Today and in the future. For the sake of our partners and the environment.

THE THREE PILLARS OF SUSTAINABILITY

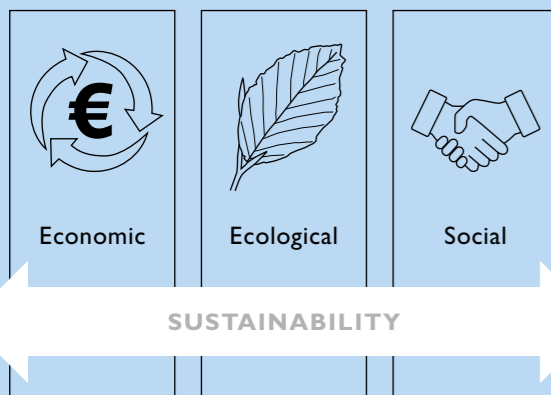

01 HYGIENE FIRST: OPTIMAL CLEANING

Did you know that the majority of contaminants are only removed when drying your hands with the hand towel? Although the microorganisms are detached from the surface of your hands with soap and water, thorough cleaning is only done by the hand towel. Our top priority in product development is to meet the highest hygiene requirements. Which is why we use paper towels. Multiple studies have shown that these are best for hygienic cleaning. It is not without reason, for example, that the medical sector relies exclusively on paper towels. They can absorb a lot of dirt and moisture with their large, open-pored surface structure. Air dryers, on the other hand, can even lead to multiplication of bacteria. When it comes to soap, we prefer to use foaming soap because it leaves a pleasant skin sensation, is particularly economical and quickly remoisturises the skin. For special requirements in the kitchen or in the medical sector, disinfection and cream dispensers are also available in the dispenser range. Leaving nothing more to be desired by customers.

Hygienic towel removal

Ille sensor technology has revolutionised the hygiene industry and proven itself time and again. It ensures contactless and portioned removal of the hygiene product from the dispenser. Our soap and disinfectant dispensers also have the sensor technology. The use of special hygienic surfaces, including special coatings for the food industry, significantly reduces bacterial growth. As a result, bacteria are not swirled around by airflow. The fresh hand towels in the dispenser are almost entirely protected against environmental influences.

Change in number of bacteria on the hands after drying

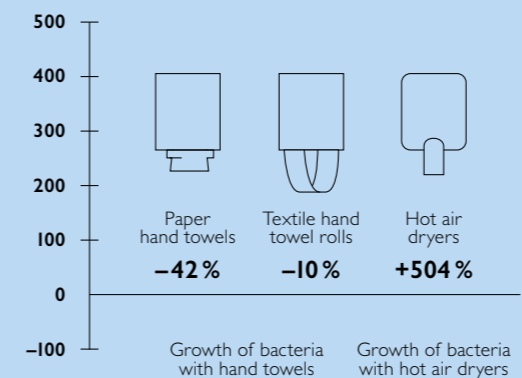

Source: University of Westminster. Study on Hand Drying Methods. 1993

Convenient wall mounting

Wall mounting of the dispensers makes it easy to clean the floors and surfaces in the washrooms. It's not just cleaning professionals who appreciate this benefit. Only with wall mounting is the tidiness of the room guaranteed and nothing can be stolen.

02 QUALITY & EFFICIENCY: MADE IN GERMANY

Our engineers take care of your problems in the bathroom with German thoroughness. Our dispensers and soaps are exclusively developed and produced in Germany. Our FSC-certified paper comes from the EU and thus meets the highest quality standards.

Economy and efficiency

The dispenser systems and refills are perfectly coordinated in order to reduce consumption, save on costs and protect the environment. We rely on the economical use of resources thanks to state-of-the-art individually adjustable dosing technology and high-quality materials which result in increased efficiency in water intake and use of resources. As much as required, as little as possible.

Use of residual soap and optimal pack sizes

Ille dispensers have a function for use of residual soap which ensures that the refills are completely used without unnecessarily losing residues. This works even if the dispenser has previously been refilled, thus significantly reducing waste. Larger packs likewise reduce packaging waste.

Production, service model and recycling

Innovative dispenser development and production in Germany ensures the most economical use of resources on the one hand and outstanding durability on the other. This is in Ille's own interest because the dispensers remain our property even when they are installed in your premises. Your benefit: we invest in the dispensers and thus save you time, money and work. We later take the dispensers back and prepare them for reuse. Parts which can no longer be used are put into plastic recycling, resulting in a 100% recycling rate (see the "Refurbishment: sustainable through and through" graphic, page 14).

Logistics and service staff

Production in Germany and Europe ensures the shortest procurement channels. A dense logistics network with around 40 branches likewise ensures proximity to customers and efficiency in trip planning. Fixed routes with friendly and well-trained core staff are extremely efficient. You can trust in the shipment of goods by your service manager. The quantities delivered are entirely sufficient to last until the next service. Thanks to streamlined organisation and exact estimation of the customer's requirements, a delivery cycle of eight weeks is normally entirely sufficient.

REFURBISHMENT
SUSTAINABLE THROUGH AND THROUGH

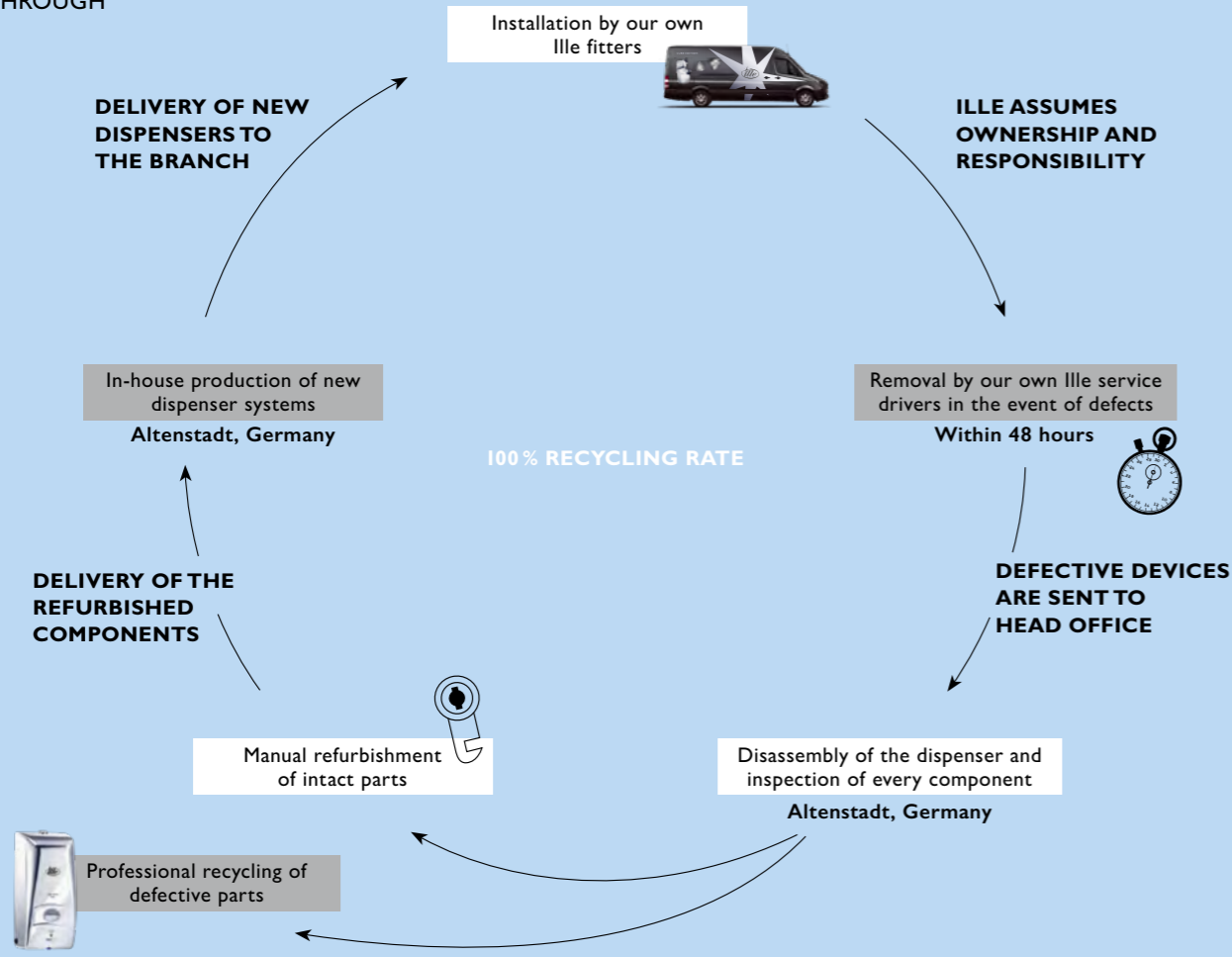

03 COMMITMENT AND SERVICE FOR PEOPLE AND THE ENVIRONMENT

Trust-based partnerships

Ille gets personally involved at our business partners' premises. We strive for long-term, trust-based partnerships. Only in this way can we find an individually optimised hygiene solution for customers. We do everything we can to make sure our customers feel optimally supplied and are happy to provide deliveries on weekends and public holidays in an emergency, for example.

Our employees

Ille is also committed to our employees. Trainees and students therefore receive intensive mentoring from experienced and well-trained employees. They are given responsibility in projects from an early stage. And regular training is provided even afterwards, so that everyone stays up-to-date.

Collaboration with universities

We work closely together with universities on research and development. Student projects and research contracts secure the latest scientific findings on the topic of hygiene for Ille. Exchange between science and practice also occurs through Ille employees' and managers' voluntary activities on the universities' official bodies.

Social projects

Every year, we support numerous social projects with a focus on children's charities, education and sport. Integration and vocational training are also themes which Ille is consistently involved with.

Environmentally-friendly drive technology

Ille has been working on environmentally-friendly drive technology for dispenser systems for years. These optimised batteries are used in the dispenser systems, ensuring efficiency and a particularly long service life. Ille takes the batteries back once they are drained and reuses them in the recycling chain. The hand towel dispensers can also be connected to the mains. Alternatively, Ille also offers a mechanical design. A fuel cell for operating the dispensers is in the trial stage.

Environmentally-friendly products

The cellulose paper used meets the highest quality requirements and is FSC-certified. This seal confirms sustainable and responsible forestry management and production right through to the end product. Alternatively, recycled paper can also be used. Disposal is done through waste paper, whereby it is put back into the paper cycle. Soap and cleaning agents are offered with an ECO label. This guarantees environmentally-friendly ingredients. In contrast to flacons, the bottles can be almost completely emptied, meaning that the resulting packaging waste is significantly reduced. Disposal is done sustainably through the green point in the yellow bin. Ille has paid for it in advance. All topics which Ille is consistently committed to.

Maintenance

The dispensers are inspected and maintained during the regular service trips. If a fault should occur despite this, we take care of it promptly. That's possible thanks to our logistics network.

Careful choice of suppliers and quality controls

Our suppliers have to meet high quality requirements. Regular visits have resulted in long-term, healthy partnerships. Thanks to a multi-sourcing strategy and in-house production, reliance on individual companies is avoided. The highest hygiene and environmental standards in the world are ensured thanks to constant quality controls at a scientific level.

Financial security

With Ille, you are supported by an experienced partner who focuses on reliability and is on a good financial footing. So that you don't have to worry about your hygiene tomorrow either.

04 RELIABILITY: SERVICE, SERVICE, SERVICE

Reliable service is important to us

With Ille, you don't have to invest or order. We do that part. Our service managers visit you at regular intervals without you needing to get in touch with us. We arrive on time and have enough goods for you in our service vehicle. Ille stores large volumes for you, which we provide immediately if needed, so that our customers only need a small storeroom.

05 INTEGRITY: THE "HONOURABLE TRADER"

The "honourable trader" is the role model for our management. Foresight leads to sustainable management and dependable business relationships. For us, this particularly includes fair dealings as equals and keeping promises. We handle your data carefully and confidentially. We strictly comply with the anti-corruption regulations and the law.

WHITE EDITION



Our classic: The White Edition design family suits and enhances every washroom and bathroom. Its pure, clean design ensures a uniform, uncluttered line. User-friendly and economical, with the innovative magic touch sensor – that is our White Edition. It makes users feel comfortable and well looked after.

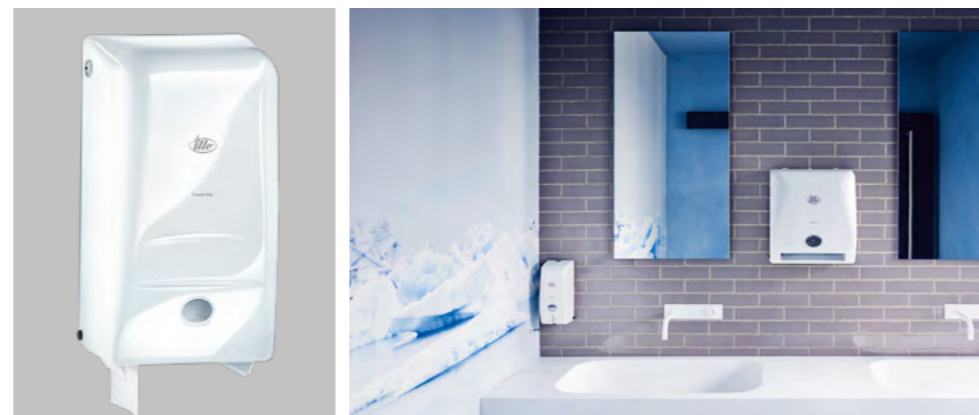

WHITE EDITION



CHROME EDITION



Classically elegant and timeless: Only Ille offers washroom hygiene in chrome colours – and places a visual highlight in your washroom. With respect to hygiene, the metal surfaces also have a great advantage. They are easily cleaned, and bacteria cannot multiply there. Upgrade your washrooms with pure elegance.



CHROME EDITION





STAINLESS STEEL EDITION

Matt brushed stainless steel ensures a uniform, sophisticated line in modern washrooms and bathrooms. The cool, understated look of our Stainless Steel Edition is particularly appreciated by architects and designers. It also has no equal when it comes to quality. The Stainless Steel Edition is so robust that it holds up under even the hardest use.

STAINLESS STEEL EDITION





BLACK EDITION

With the Black Edition, your washroom becomes a destination. The Black Edition not only emphasizes the features but also sets the standard. At the same time, it is very much in tune with current trends. Its special surfaces ensure a long-lasting shine, and the impressive technology meets even the highest demands. This product line, entirely in black, will leave your guests with a lasting impression even in heavily used bathrooms.

BLACK EDITION





Tricky Ricky in the following variants: Hand wash, body & hair, body & care or as the eco label edition (for a fee)

WAVE EDITION

The modern and luxurious hotel bathroom furnishings ensure an atmosphere of well-being for your guests – and for you, the good feeling that you have made the right decision: economical, hygienic, well thought-out down to the smallest detail. In terms of providing quality, service and expertise to the hospitality industry, Ille stands without a peer.



HANKY PANKY



PRIMA DIVA



WAVE WILLY



DANNY DENTAL



TRICKY RICKY



SECRET LADY



OUR PRODUCTS

Our products are continually further developed and optimised. Only then can we achieve our goal: absolute hygiene, easy operation, reliable technology and timeless design – at economical prices.

Continuous quality control is firmly integrated into our processes and are documented. We work only with the best materials and place great emphasis on premium quality, as that guarantees satisfied customers. Our team works to this end with enthusiasm, professionalism and great expertise.

We adapt to the individual needs of each customer by learning about their requirements onsite and working with our technicians to find the best solutions. It's goal-oriented and effective! Our production in Germany ensures a great deal of flexibility as well as adherence to our accustomed standards of quality – that is 100 % IIIe.

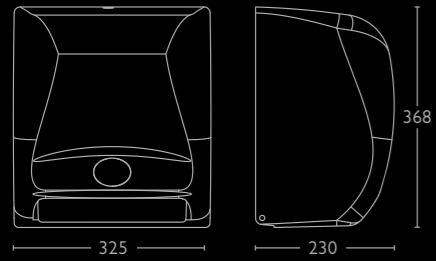

PAPER JACK

TOWEL
TISSUE DISPENSER
ELECTRONIC

DISPENSER DIMENSIONS

Width	325 mm
Height	368 mm
Depth	230 mm

PAPER MAX

PAPER CONTAINER



DISPENSER DIMENSIONS

Width	303 mm
Height	915 mm
Depth	355 mm

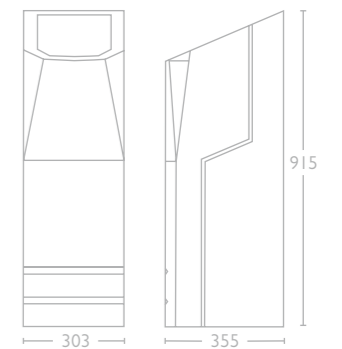

PAPER³



PAPER CONTROL

TOWEL
TISSUE DISPENSER
ELECTRONIC

Like its name suggests, Paper Control is a supervisory body for economical paper consumption. Under the motto "preventing paper waste", this version of the Paper Jack allows the sensor to release again only after the first sheet is torn off. This is possible thanks to a knife switch fitted into the transmitter. This therefore prevents the unintentional release or waste of paper in narrow washrooms.

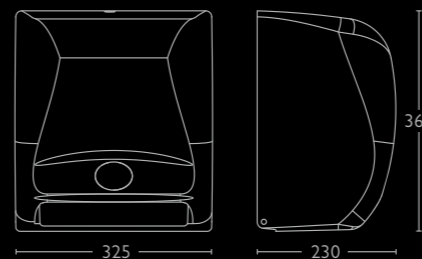

DISPENSER DIMENSIONS

Width	325 mm
Height	368 mm
Depth	230 mm

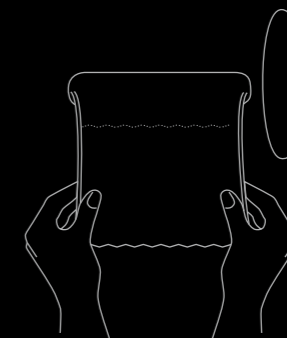

PAPER FEED

TOWEL
TISSUE DISPENSER
ELECTRONIC

Where on earth is the paper? The employees at Porsche wondered. Inspired by this, this version of the Paper Jack was especially developed for the automotive group. The electronic variant of the Paper Cut supplies the user with hand paper towels without having to activate the sensor. After the paper is torn off, new paper is automatically dispensed. A user-friendly solution for industry, commerce and crafts.

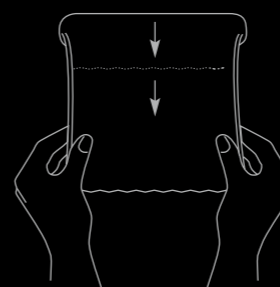

PAPER CUT

TOWEL
TISSUE DISPENSER
MECHANICAL

Paper Cut is the mechanical version of the Paper Jack operated with the sensor. To enable a mechanical design of the round dispenser, an automatic cutting device is installed in the dispensers. This is triggered when the customer pulls the paper out of the dispenser. In this way, the hand paper towels are portioned and efficiently supplied in the washroom without additional electronics. An energy-independent solution for technically difficult areas and environmentally conscious customers.

Product image: Sample illustration of the paper jack in a classic design.

ALSO COMES IN





CREAM & CARE

CLEAN ATTACK
ELECTRONIC

DISPENSER DIMENSIONS

Width	110 mm
Height	245 mm
Depth	113 mm

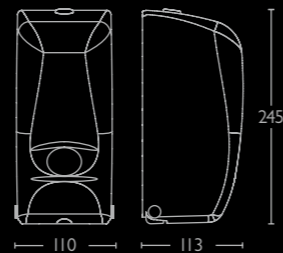

SANITIZER

CLEAN ATTACK
MECHANICAL



FOAM

CLEAN ATTACK
MECHANICAL

SOAP

CLEAN ATTACK
MECHANICAL



DISPENSER DIMENSIONS

Width	113 mm
Height	289 mm
Depth	114 mm

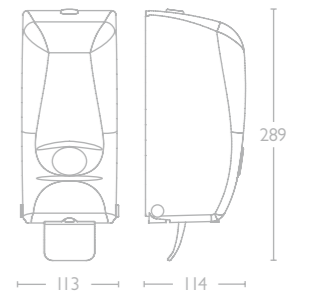

LIQUID

CLEAN ATTACK
MECHANICAL



PAPER JACK

TOWEL
TISSUE DISPENSER
MECHANICAL

DISPENSER DIMENSIONS

Width	328 mm
Height	365 mm
Depth	224 mm

ROLL DIMENSIONS

Ø Outer	150 mm
Ø Inner	50 mm
Width	215 mm

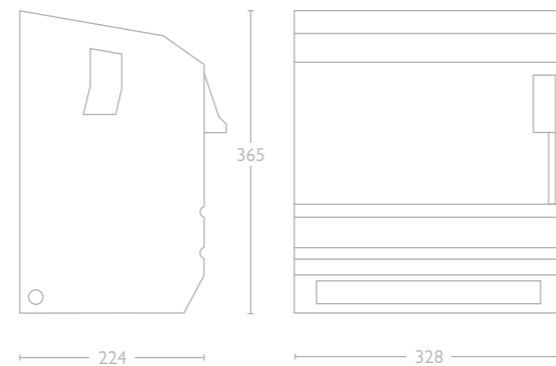

HANKY PANKY

COSMETIC
TOWEL DISPENSER

DISPENSER DIMENSIONS

Width	270 mm
Height	153 mm
Depth	66 mm

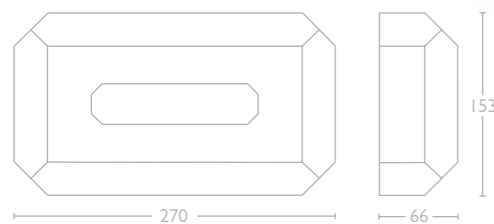

TRIPLE WILLY

TOILET
TISSUE DISPENSER

DISPENSER DIMENSIONS

Ø	370 mm
Height	378 mm
Depth	110 mm

ROLL DIMENSIONS

Ø Outer	115 mm
Ø Inner	50 mm
Width	100 mm

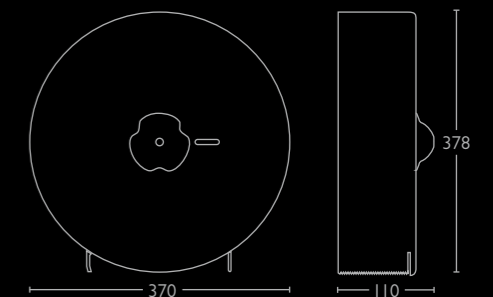

FRAGRANCES

CLEAN ATTACK

Choose one of the exclusive fragrance packages and Ille full service transforms your toilet facilities into heady worlds of fragrance. We automatically stock your Clean Attack Fresh Dispenser with one of the more than 16 fragrant scents during each service appointment. Surprise your guests anew on every visit with unique fragrance creations – at no extra cost.

1
oz

FRUIT COCKTAIL

Lemons, oranges, apples or mandarins are in vogue at more than just the weekly market. We have perfectly balanced the fragrance of sun-ripened fruit and preserved it for you.



2
oz

FLOWER POWER

The fragrant backdrop of a bouquet of flowers in your sanitary facilities. The harmonious scents of lavender, lilac, orchids or jasmine create floral lightness.

3
oz

SPICE MIX

Inspired by the most popular spices of the Orient. Experience exotic fragrances with aromatic vanilla, anise, cinnamon or clove scents.



4
oz

COOL PACK

As refreshing as a summer breeze. Notes of pine needles, mint, bergamot or iris create pleasant cooling in any restroom.

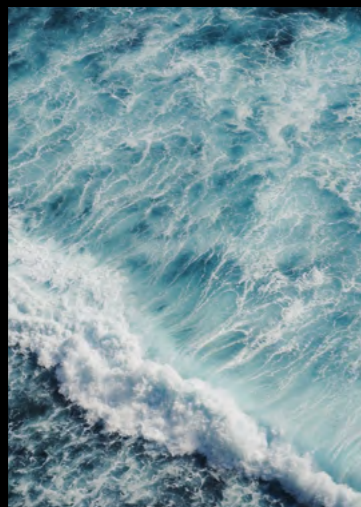

FRESH

CLEAN ATTACK ELECTRONIC

DISPENSER DIMENSIONS

Width	110 mm
Height	245 mm
Depth	113 mm

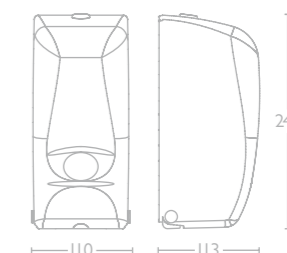

ALL FRAGRANCE PACKS

1 LIMONE
ARANCIA
MELA
MANDARINO

2 LAVANDA
LILLA
ORCHIDEA
FIORE

3 VANILLA
ANIS
CINNAMON
CARNATION

4 WOODLAND
BREEZE
MISTRAL
OCEAN

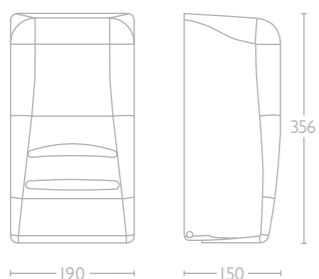
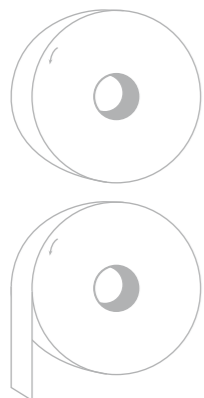

DOUBLE WILLY

TOILET TISSUE DISPENSER

DISPENSER DIMENSIONS

Width	190 mm
Height	356 mm
Depth	150 mm



DOUBLEWILLY ALSO COMES IN

LIQUID

CLEAN ATTACK ELECTRONIC

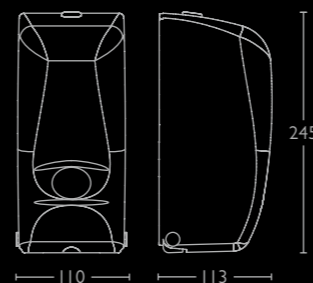

DISPENSER DIMENSIONS

Width	110 mm
Height	245 mm
Depth	113 mm



SANITIZER

CLEAN ATTACK ELECTRONIC

POLLY DOLLY

TOILET BRUSH HOLDER

DIMENSIONS

Width	160 mm
Height	210 mm
Depth	140 mm

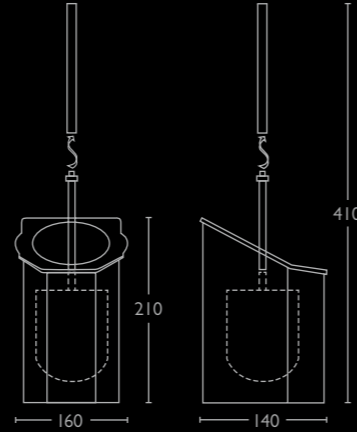

SECRET SERVICE

LADIES AND GENTLEMEN HYGIENE

DISPENSER DIMENSIONS

Width	107 mm
Height	143 mm
Depth	28 mm

WASTE BIN DIMENSIONS

Width	220 mm
Height	275 mm
Depth	200 mm

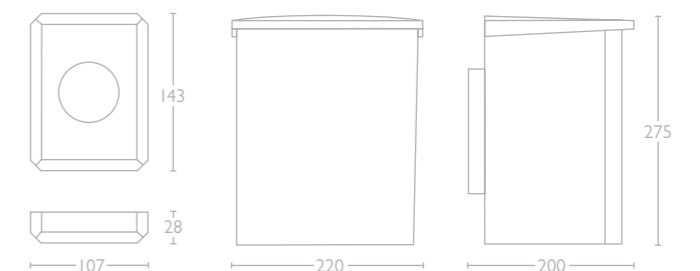



CLEAN ATTACK

CABINET

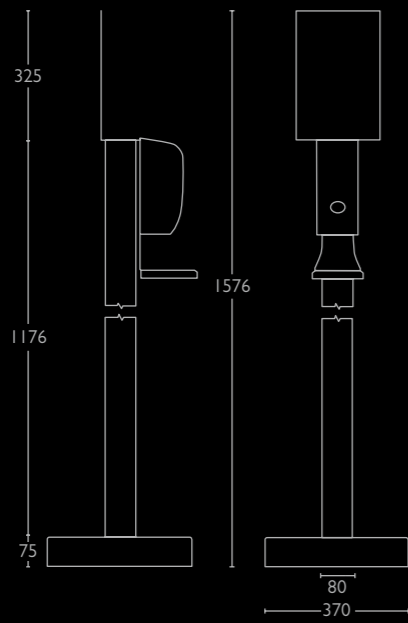

DISPENSER DIMENSIONS

Width 370 mm
 Height 1576 mm
 Ø Stand 370 mm

PAPER SAFE

ELECTRONIC
 TOWEL TISSUE DISPENSER
 INCL. BIN

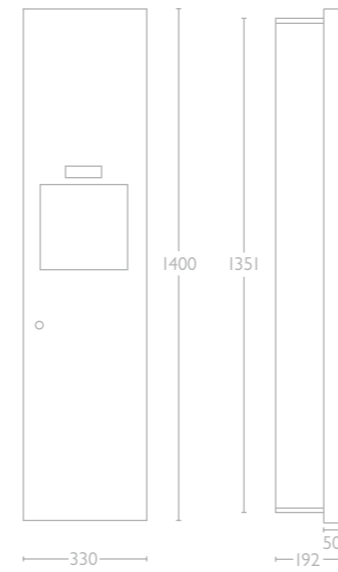

DISPENSER DIMENSIONS

Width 330 mm
 Height 1400 mm
 Depth 192 mm

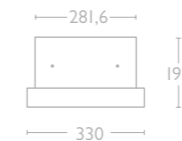

DISPENSER DIMENSIONS

Width 330 mm
 Height 1400 mm
 Depth 158 mm

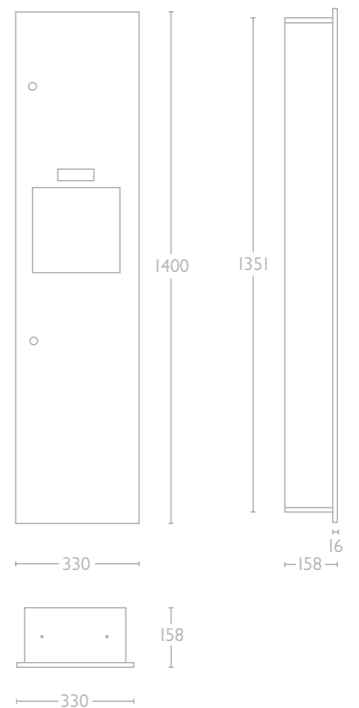

BABY BOND

BABY CHANGING TOWEL DISPENSER



DISPENSER DIMENSIONS VERTICAL

Width	560 mm
Height	899 mm
Height Closed	112 mm
Height Open	903 mm

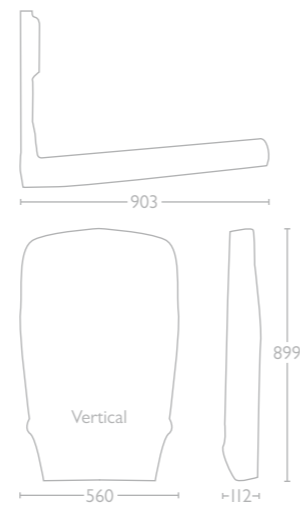

BABY SET

BABY NAPPY

BABY CHANGING TABLE



DISPENSER DIMENSIONS HORIZONTAL

Width	872 mm
Height	510 mm
Height Closed	102 mm
Height Open	513 mm

KITCHEN



KITCHEN

CLEAN ATTACK

DISPENSER DIMENSIONS

Width	430 mm
Height	600 mm
Depth	123 mm

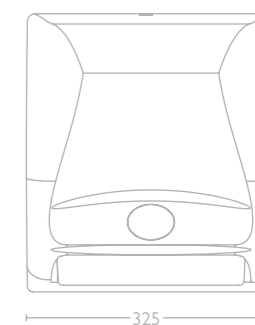
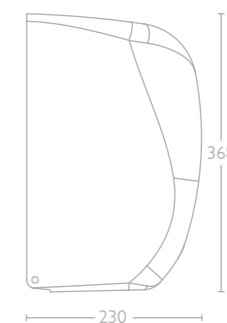
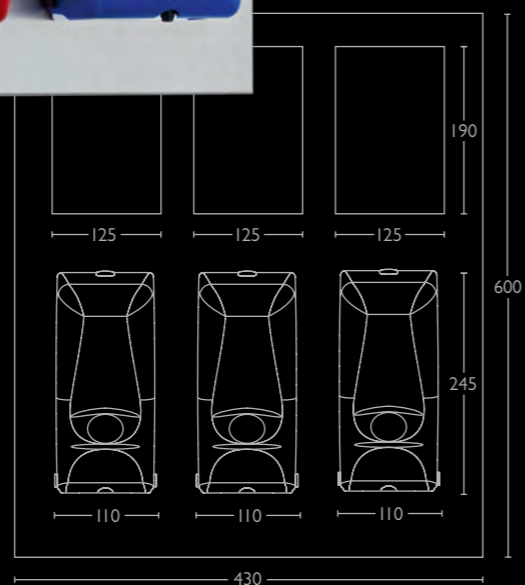

PAPER JACK

NANO
TOWEL TISSUE DISPENSER
ELECTRONIC

DISPENSER DIMENSIONS

Width	325 mm
Height	368 mm
Depth	230 mm

ROLL DIMENSIONS

Ø Outer	150 mm
Ø Inner	50 mm
Width	215 mm



PIT STOP



**TANK
TOMMY**
TANK GLOVE DISPENSER



DISPENSER DIMENSIONS

Width	270 mm
Height	153 mm
Depth	66 mm

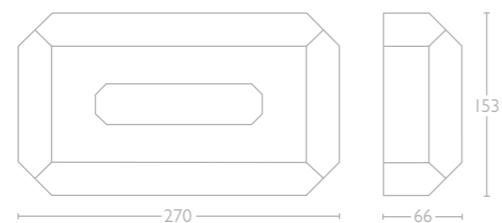

PAPER JACK

TOWEL
TISSUE DISPENSER
MECHANICAL

DISPENSER DIMENSIONS

Width	328 mm
Height	365 mm
Depth	224 mm

ROLL DIMENSIONS

Ø Outer	150 mm
Ø Inner	50 mm
Width	215 mm

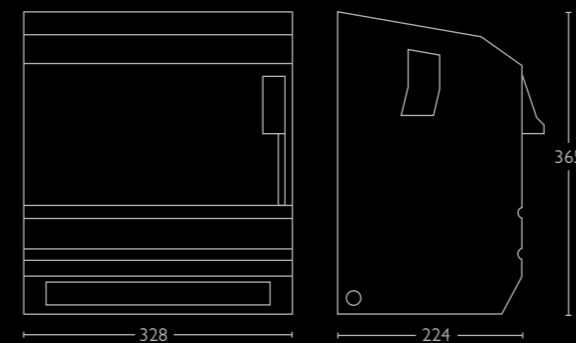

BIG MAMA

CLEANING ROLLER BRACKET & CLEANING ROLLER CABINET

DISPENSER DIMENSIONS BRACKET

Width	555 mm
Height	610 mm
Depth	275 mm

DISPENSER DIMENSIONS CABINET

Width	555 mm
Height	1025 mm
Depth	710 mm



GARAGE FACTORY



HEAVY METAL

FOLDED PAPER DISPENSER

DISPENSER DIMENSIONS

Width	270 mm
Height	355 mm
Depth	127 mm

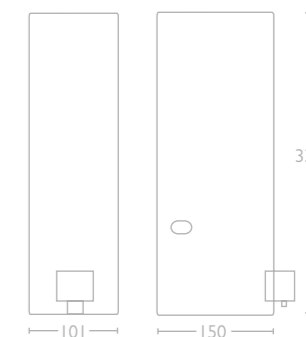
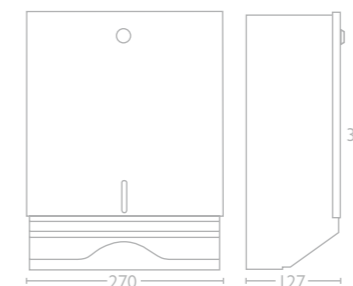

PASTY PADDY

PASTE SOAP DISPENSER

DISPENSER DIMENSIONS

Width	101 mm
Height	332 mm
Depth	150 mm





DIRTY HARRY

SUPER ABSORBENT
FLOOR MAT

DIMENSIONS

Small	850 x 1500 mm
Medium	1150 x 1800 mm
Large	1150 x 2400 mm

DIRTY HARRY ALSO COMES IN



HYGIENE HIGH- LIGHTS

CLEANING AGENT

- ✓ Free from phosphates and nanoparticles.
- ✓ HACCP certificates of free sale available for all products.



Sustainability is important to us. ILLE RED, ILLE BLUE and ILLE YELLOW therefore have double certification. Both the "EU Ecolabel" and "Blue Angel" quality seals attest to top environmental performance.



ILLE RED
bath & toilet

The fruit acid-based sanitary maintenance cleaner cleans without adding hydrochloric acid. ILLE RED is suitable for sparing use on acid-resistant materials in washrooms and toilet facilities. This includes tiles, porcelain, stoneware, ceramics, and artificial stone, as well as basins, toilets and other sanitary facilities. The pleasant fragrance ensures delightful freshness.



ILLE BLUE
domestic

The mild ILLE BLUE universal cleaner cleans all water-resistant surfaces without any substances that leave grease or a film. The clean surfaces dry quickly and without any residue, with no streaks and smears. Suitable for use on glass, plastic, ceramic wall and floor tiles, laminate, sealed wooden floors, PVC, linoleum, artificial and natural stone surfaces. Particularly gentle and fresh thanks to the lustre alcohol it contains.



ILLE YELLOW
floor

ILLE YELLOW – the cleanser made from water-soluble polymers for daily maintenance cleaning. Suitable for manual and machine application on all water-resistant floor coverings. The cleaner can be polished and is suitable for high-speed treatment. With the fragrance of fresh lemons.



ILLE GREEN
kitchen

ILLE GREEN can be used manually and with machines (including high-pressure cleaners) in the catering industry and food processing operations to remove grease, oil and soot. Suitable for cleaning floors, walls, ceilings and work surfaces, equipment and all alkali-resistant floor coverings. ILLE GREEN stands out with good dispersion and is certified for use in the food industry. The cleaner is biodegradable in accordance with the EU Regulation on Detergents.

*"A clean
FUTURE WITH ILLE
Prospects that have cleaned up."*

Special service requires special training. We took this principle to heart from the very beginning and train young people with great dedication and passion. From training as storage specialists, versatile service drivers, IT specialists with an overview, and friendly and competent sellers through to studies in various fields of business administration, IT or engineering – it's all important to Ille. By rotating through the departments, the youngsters learn all of the processes from scratch and are trained as Ille specialists. And there are plenty of opportunities after completing the vocational training or degree because people are our top priority.



ILLE IN EUROPE

ILLE INTERNET: WWW.ILLE.EU

GERMANY, SWITZERLAND, LUXEMBOURG

Headquarter
 Ille Papier-Service GmbH
 Industriestraße 25
 63674 Albstadt
 Phone: +49 (0) 6047 980-0
 Fax: +49 (0) 6047 980-70
 Email: vertrieb@ille.eu

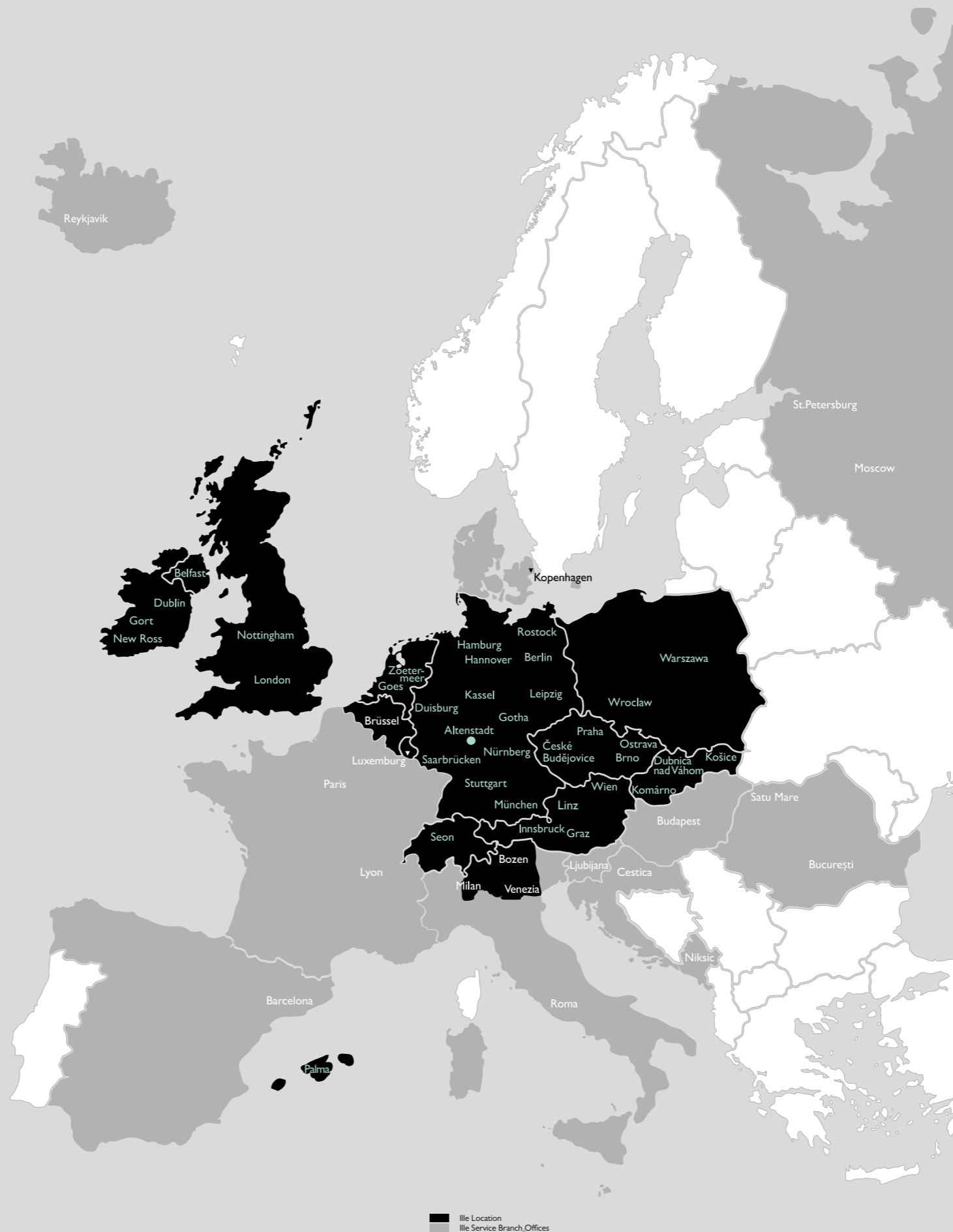

AUSTRIA

Ille Papier-Service GmbH
 Theodor-Sickel-Gasse 8
 1100 Wien
 Phone: +43 (0) 1 6883015
 Fax: +43 (0) 1 6883015-20
 Email: info@illepapier.at

REPUBLIC OF IRELAND AND NORTHERN IRELAND

Ille Service (IRL) Ltd.
 Talbot Hall, New Ross
 Co. Wexford, Ireland
 Y34 H267
 Phone: +353 (0) 51 441-000
 Fax: +353 (0) 51 420-566
 Email: sales@ille.ie

SLOVAKIA

ILLE-Papier-Service SK, spol. s r.o.
 Lieskovec 856/133
 018 41 Dubnica nad Váhom
 Phone: +421 (0) 32 6484203
 Email: ille@ille.sk

NETHERLANDS

Ille Papier-Service Nederland B.V.
 Verrijn Stuartweg 6
 4462 GE Goes
 Phone: +31 (0) 113 253-222
 Email: info@illepapier.nl

CZECH REPUBLIC

Ille service spol. s r.o.
 Toužimská 856
 199 00 Praha 9
 Phone: +420 271 723-023
 Email: info@ille-papir.cz

POLAND

Ille Service Polska sp. z o.o.
 Ul. Macieja Miechowity 3 / 1-19
 51-162 Wrocław
 Phone: +48 576 333 499
 Email: info@ille.pl

GREAT BRITAIN

Ille Paper Services UK Ltd.
 Unit 6, Drakehouse Court
 Hamilton Road, Sutton in Ashfield
 NG17 5LD Nottinghamshire
 Phone: +44 (0) 1623 559182
 Email: sales@illepaper.co.uk

BALEARIC ISLANDS

Ille Higenio S.L.
 Calle Joan Maria Thomas 2, Planta I
 07014 Palma de Mallorca
 Phone: +34 971 228 368
 Fax: +34 971 228 081
 Email: servicio@ille.es

SWITZERLAND

Ille Service CH GmbH
 Birren 31
 5703 Seon
 Phone: +41 (0) 44 775 55 00
 Fax: +49 (0) 6047 980-70
 Email: service@ille.ch



ILLE SERVICE (IRL) LTD.

Talbot Hall, New Ross
Co. Wexford, Ireland
Y34 H267

PHONE +353 (0) 51 441-000

FAX +353 (0) 51 420-566

ille.eu
sales@ille.ie